

PS-12E03

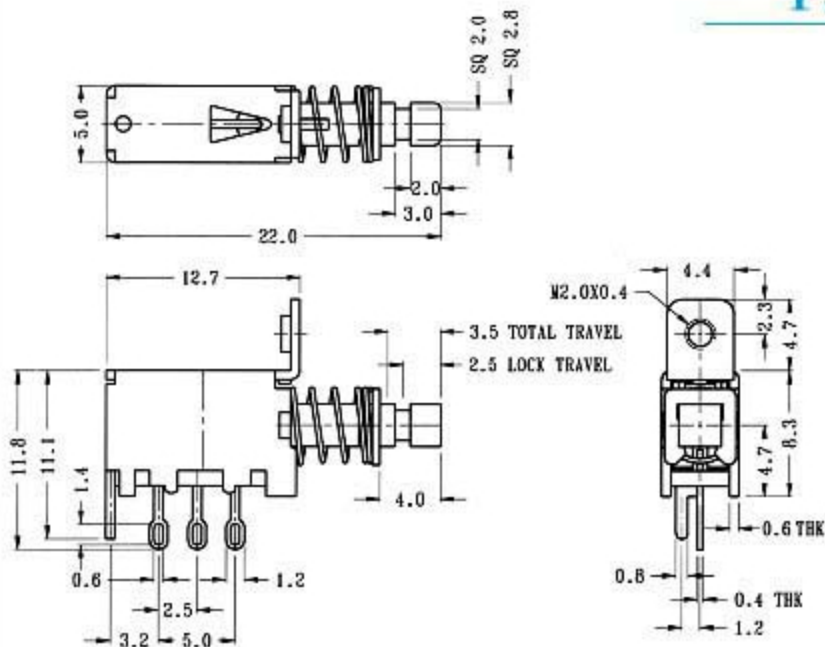

CIRCUIT DIAGRAM



SPECIFICATIONS

Rating :0.3A 50V DC
Function: 1P2T