

PS-22F09
PS-22F10

(LOCKED)

(NON-LOCKED)

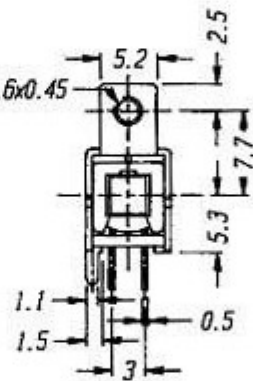
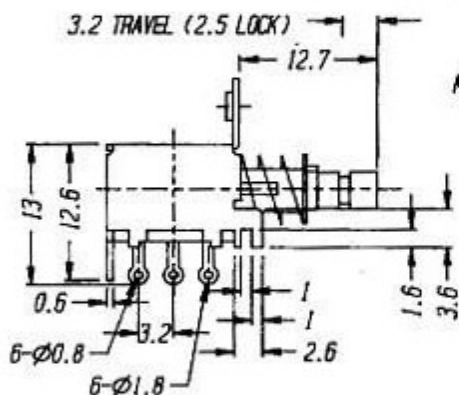
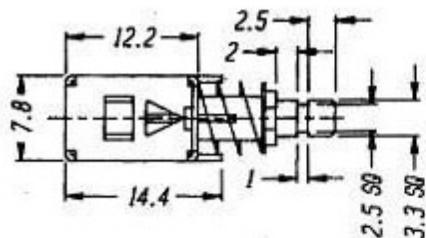

CIRCUIT DIAGRAM

SPECIFICATIONS

NON-SHORTING

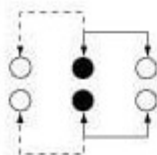

Rating : 0.3A 50V DC

Function: 2P2T