

SS-23H12

Optional knob type

MX	AT	NY	GD		

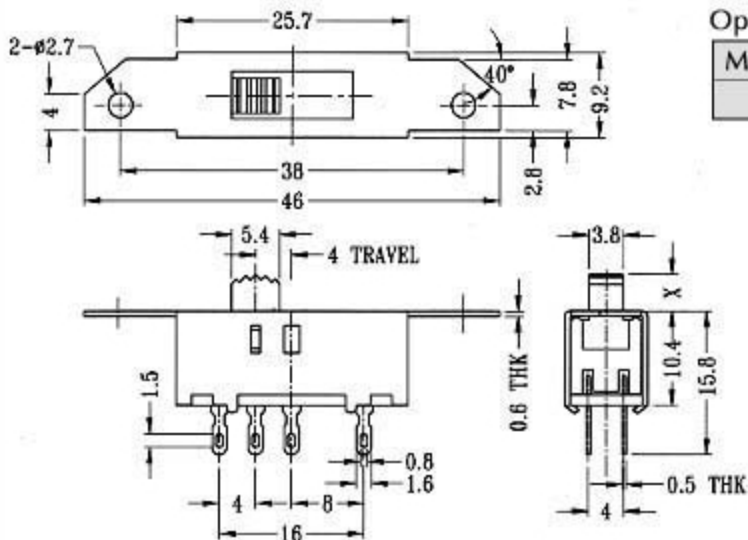

CIRCUIT DIAGRAM

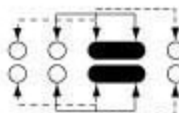

SPECIFICATIONS

Rating: 0.3A 50V DC

Function: 2P3T